



# Samskrár – samstarf sem aldrei lýkur

maí 2005

Kynning fyrir stjórnendur bókasafna um  
stöðu bókfræðilegra upplýsinga í Gegni

Sigrún Hauksdóttir

# Skyldu okkar vandamál vera einstök?



# Ó, nei

- Mismunandi söfn
- Mismunandi þarfir
- Mismunandi hefðir
- Mismunandi skráningarfærni
- o.s.frv.



# Allavegna samskrár

- Gegnir
- Libris
- Þýskaland
- Samskonar söfn
- Mismunandi
- Litlar
- Stórar



# Single Local System

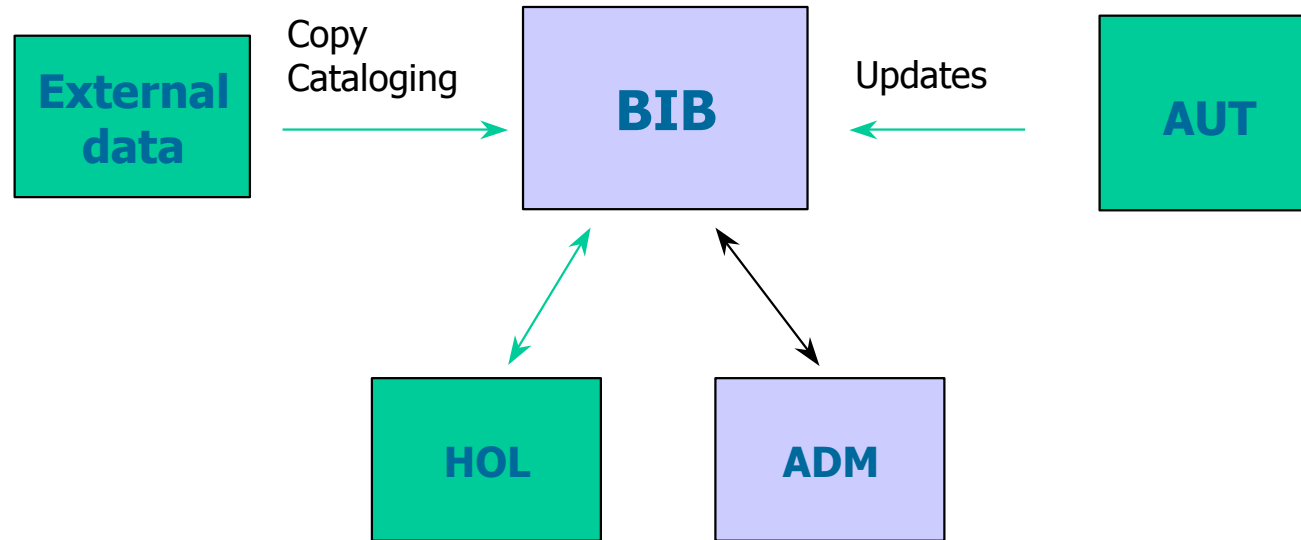

# Single BIB with Multi-ADM Libraries

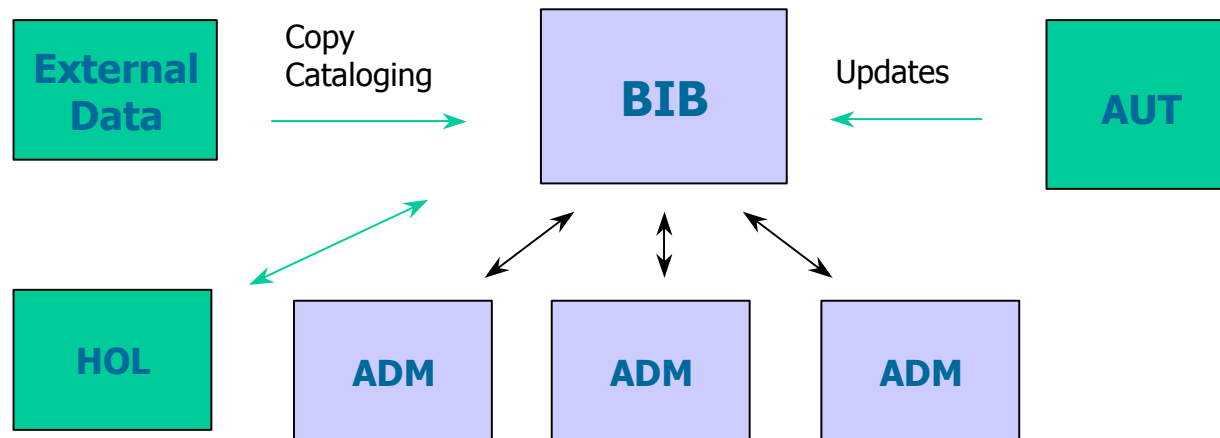

# Multiple Local Systems – Shared Installation

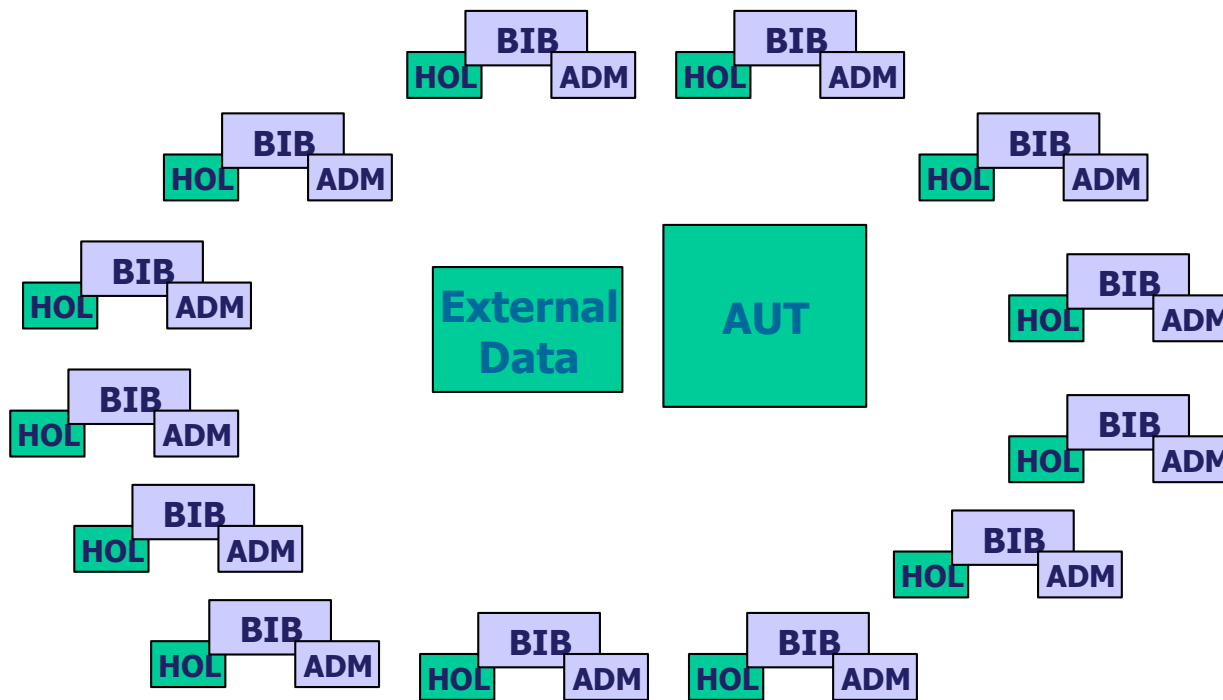

# Virtually De-duplicated Union Catalog (Union View) with Multi-ADM

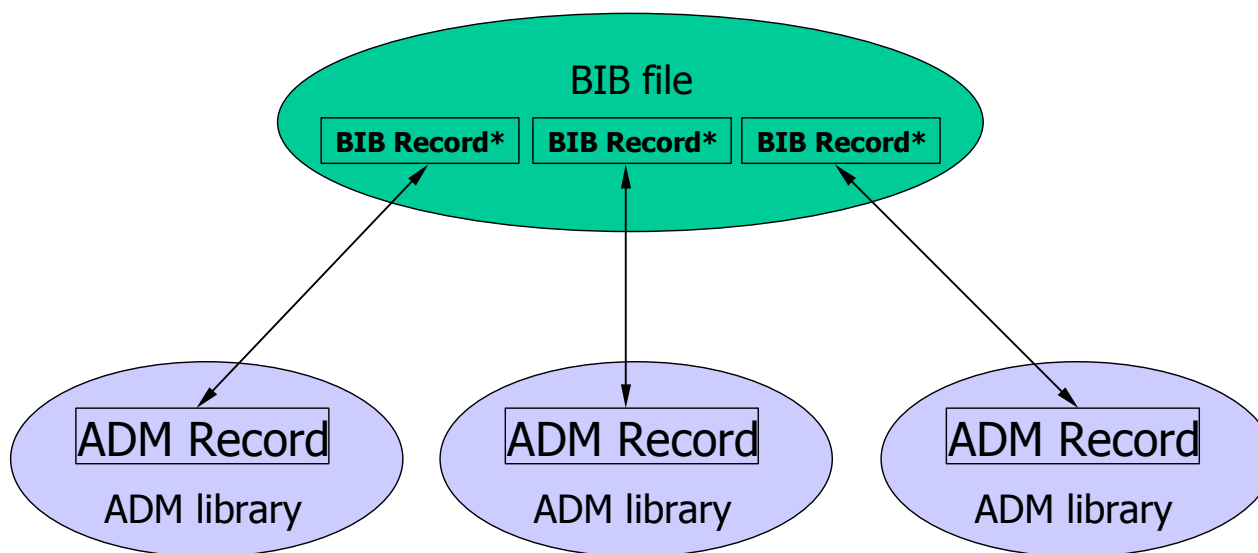

\* Three copies of the same BIB record



# Separate Catalogs and a Union Catalog

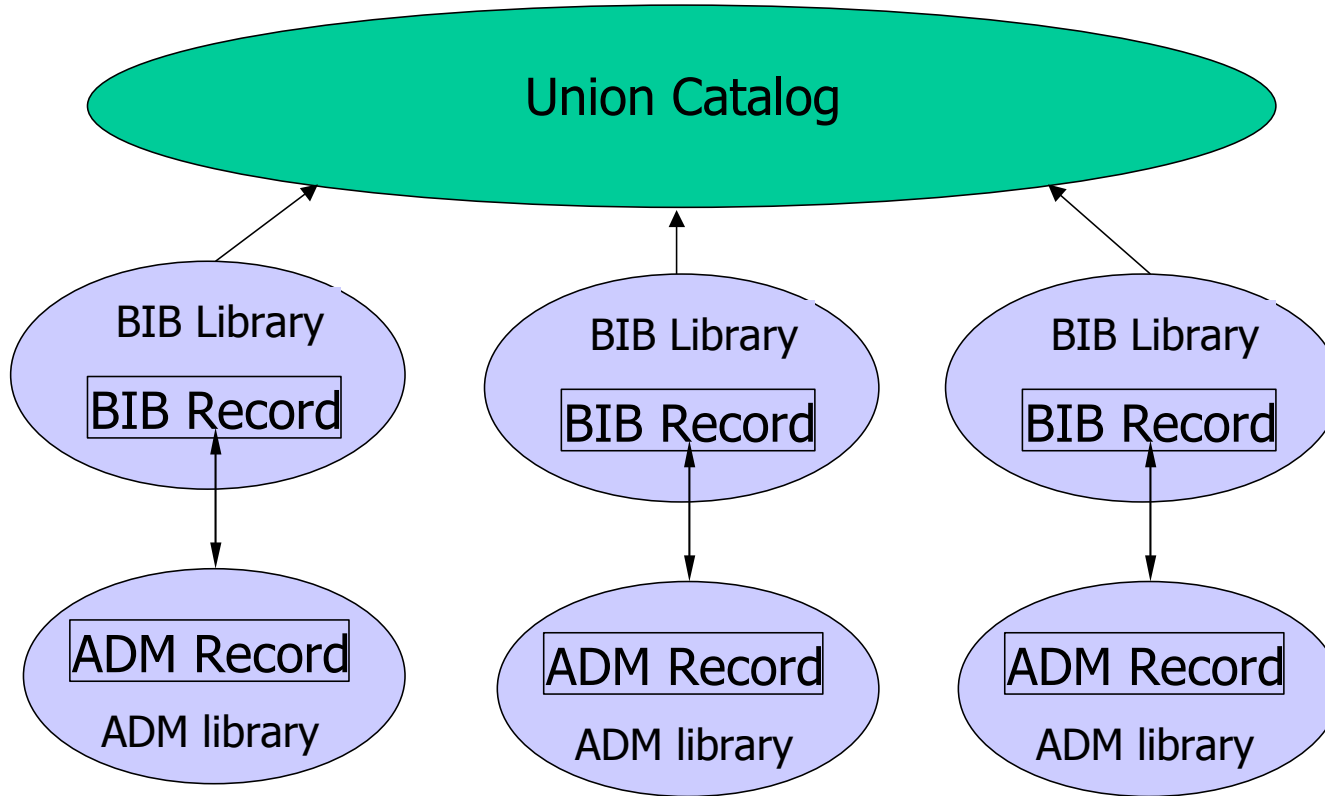

# Central Catalog – ALEPH Cluster

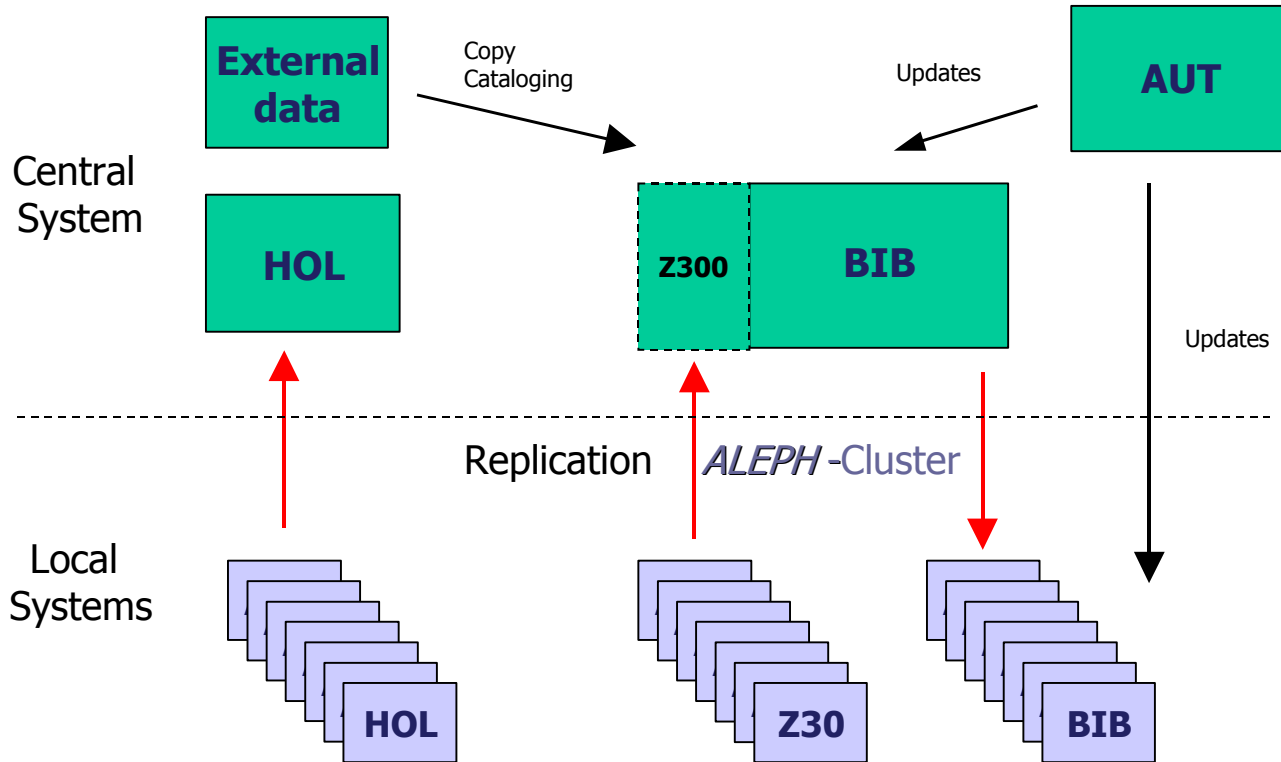

# Central Catalog – Local Owner Update -> Non-ALEPH Local Systems

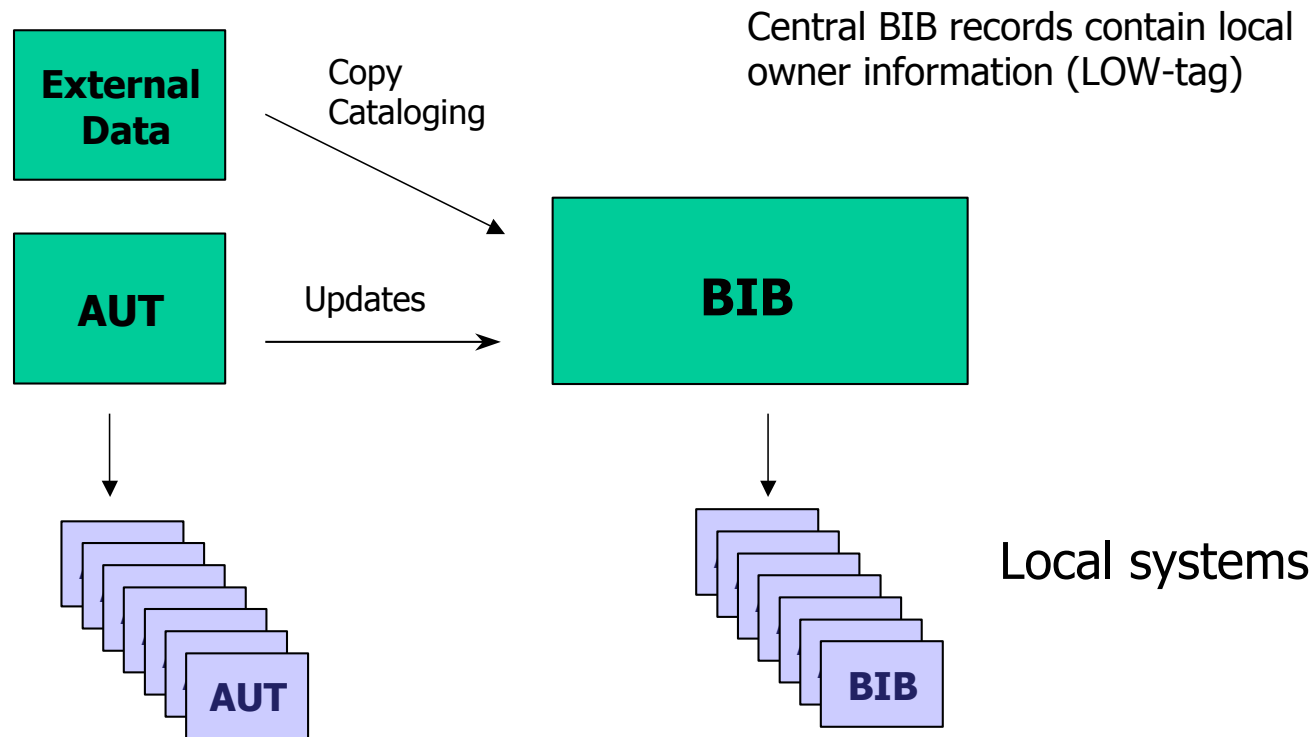

# Hvernig er skráningu háttað?

- Hver safn skráir
- Sameiginleg skráning
- Og allt þar á milli
  
- Gæðastjórnun er alltaf vandamálið



# Samstarf sem aldrei lýkur

- Samvinna
- Sameiginlegar reglur
- Lúta einni stjórn
- Átaksverkefni
- Ágreiningsefni
- Endalausir fundir



- Samvinna
- Samvinna
- Samvinna
- Samstarf
- Samstarf
- OG SAMSTARF

